

LUXEON H50-2

High Voltage LED

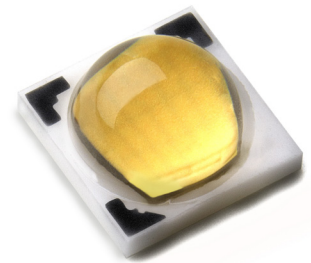

Introduction



The LUXEON® H50-2 delivers superior efficacy, color performance and reliability in a high voltage architecture that minimizes driver requirements making it an ideal solution for space constrained and cost sensitive retrofit bulbs and luminaires. With exceptional color stability over temperature and current, LUXEON H50-2 simplifies design while providing superior quality of light.

This document contains the performance data and technical information needed to design and develop LUXEON H50-2 based solutions.

Features and Benefits

- Enables design of small socket and cost sensitive luminaires with simple, efficient and small size driver
- Is binned at 85°C and 40 mA with 3 and 5 SDCM color binning. 50V 2 watt LED flexibly supports 110V and 220V solutions.
- Exceeds ENERGY STAR® lumen maintenance requirements
- Delivers real-world in application performance and reliability.

Key Applications

- Lamps
- Specialty Lighting

Table of Contents

General Information	2
Product Nomenclature	2
Average Lumen Maintenance Characteristics	2
Environmental Compliance	2
Product Selection	3
Optical Characteristics	3
Electrical Characteristics	4
Absolute Maximum Ratings	5
JEDEC Moisture Sensitivity	5
Reflow Soldering Characteristics	6
Mechanical Dimensions	7
Solder Pad Design	8
Relative Spectral Distribution vs. Wavelength Characteristics	9
Light Output Characteristics	11
Typical Forward Current Characteristics	12
Typical Radiation Patterns	13
Emitter Pocket Tape Packaging	14
Emitter Reel Packaging	15
Product Binning and Labeling	16
Color Bin Structure	18
LUXEON H50-2 3-step and 5-step MacAdam Ellipse Color Definition	19

General Information

Product Nomenclature

LUXEON H50-2 is tested and binned at 40 mA, with current pulse duration of 20 ms. All characteristic charts where the thermal pad is kept at constant temperature (85°C typically) are measured with current pulse duration of 20 ms. Under these conditions, junction temperature and thermal pad temperature are the same.

The part number designation is explained as follows:

L X A C - A B C D

Where:

A — 1 for current design of H50-2

B — 8 for 80 CRI

C, D — 27 for 2700K, 30 for 3000K

Therefore 80 CRI products tested and binned at 2700K will have the part numbering scheme:

L X A C - 1 8 2 7

Average Lumen Maintenance Characteristics

Lumen maintenance for solid state lighting devices (LEDs) is typically defined in terms of the percentage of initial light output remaining after a specified period of time. Philips Lumileds projects that LUXEON H50-2 products will deliver, on average, 70% lumen maintenance (L70) \geq 36,000 hours at a drive current of 40 mA. This projection is based on constant current operation with the T_s temperature maintained \leq 105°C. This performance is based on independent test data, extrapolation according to IESNA TM-21-11 of Philips Lumileds historical data from tests run on similar material systems, and internal LUXEON reliability testing. Observation of design limits included in this data sheet is required in order to achieve this projected lumen maintenance.

Environmental Compliance

Philips Lumileds is committed to providing environmentally friendly products to the solid-state lighting market. LUXEON H50-2 is compliant to the European Union directives on the restriction of hazardous substances in electronic equipment, namely the RoHS and REACH directives. Philips Lumileds will not intentionally add the following restricted material to the LUXEON H50-2: lead, mercury, cadmium, hexavalent chromium, polybrominated biphenyls (PBB) or polybrominated diphenyl ethers (PBDE).

Product Selection

Product Selection for LUXEON H50-2

Thermal Pad Temperature = 85°C, Test Current = 40 mA

Table 1.

Nominal CCT	Part Number	Minimum CRI	Minimum Luminous Flux (lm)	Typical Luminous Flux (lm)	Typical Efficacy (lm/W)
2700K	LXAC-1827	80	150	165	83
2700K	LXAC-1927	90	110	140	70
3000K	LXAC-1830	80	160	175	88
4000K	LXAC-1840	80	170	200	100
5000K	LXAC-1850	80	175	205	103
6500K	LXAC-1765	70	190	220	110

Note for Table 1:

1. Philips Lumileds maintains a tolerance of $\pm 6.5\%$ on luminous flux and ± 2 on CRI measurements.

Optical Characteristics

Optical Characteristics for LUXEON H50-2

Thermal Pad Temperature = 85°C, Test Current = 40 mA

Table 2.

Nominal CCT	Minimum CRI	Color Temperature CCT			Typ Total Included Angle ^[1] (degrees) $\theta_{0.90V}$	Typ Viewing Angle ^[2] (degrees) $2\theta_{1/2}$
		Minimum	Typical	Maximum		
2700K	80	2580K	2725K	2870K	135	110
2700K	90	2649K	2773K	2850K	135	110
3000K	80	2870K	3045K	3220K	135	110
4000K	80	3598K	4051K	4176K	135	110
5000K	80	4462K	4985K	5181K	135	110
6500K	70	4856K	6322K	7170K	135	110

Notes for Table 2:

1. Total angle at which 90% of total luminous flux is captured.

2. Viewing angle is the off axis angle from lamp centerline where the luminous intensity is $\frac{1}{2}$ of the peak value.

Electrical Characteristics

Electrical Characteristics for LUXEON H50-2

Thermal Pad Temperature = 85°C, Test Current = 40 mA

Table 3.

Nominal CCT	Forward Voltage V_f ^[1] (V)			Typ. Temperature Coefficient of Forward Voltage ^[2] (mV/°C) $\Delta V_f / \Delta T_j$	Typical Thermal Resistance Junction to Thermal Pad (°C/W) $R\theta_{j-c}$
	Minimum	Typical	Maximum		
2700K, 3000K 4000K, 5000K, 6500K	48.5	50.0	52.0	-30.0	3

Notes for Table 3:

1. Philips Lumileds maintains a tolerance of $\pm 0.5\%$ on forward voltage measurements.
2. Measured between $25^\circ\text{C} \leq T_j \leq 125^\circ\text{C}$ at $I_f = 40 \text{ mA}$.

Absolute Maximum Ratings

Table 4.

Parameter	Maximum Performance
DC Forward Current (mA)	45
RMS Forward Current (mA) ^[2]	45
Peak Current (mA) ^[2]	65
ESD Sensitivity	< 1000V Human Body Model (HBM) Class 2 JESD22-A114-B < 400V Machine Model (MM) Class 2 JESD22-A115-B
LED Junction Temperature ^[1]	125°C
Operating Case Temperature at 40 mA	-40°C - 118°C
Storage Temperature	-40°C - 135°C
Soldering Temperature	JEDEC 020c 260°C
Allowable Reflow Cycles	3
Autoclave Conditions	121°C at 2 ATM 100% Relative Humidity for 96 Hours Maximum
Reverse Voltage (Vr)	LUXEON H LEDs are not designed to be driven in reverse bias

Notes for Table 4:

1. Proper current derating must be observed to maintain junction temperature below the maximum.
2. For AC operation with a minimum of 50Hz.

JEDEC Moisture Sensitivity

Table 5.

Level	Soak Requirements			
	Floor Life		Standard	
	Time	Conditions	Time	Conditions
I	unlimited	≤ 30°C / 85% RH	168 Hrs. + 5 / -0 Hrs.	85°C / 85% RH

Reflow Soldering Characteristics

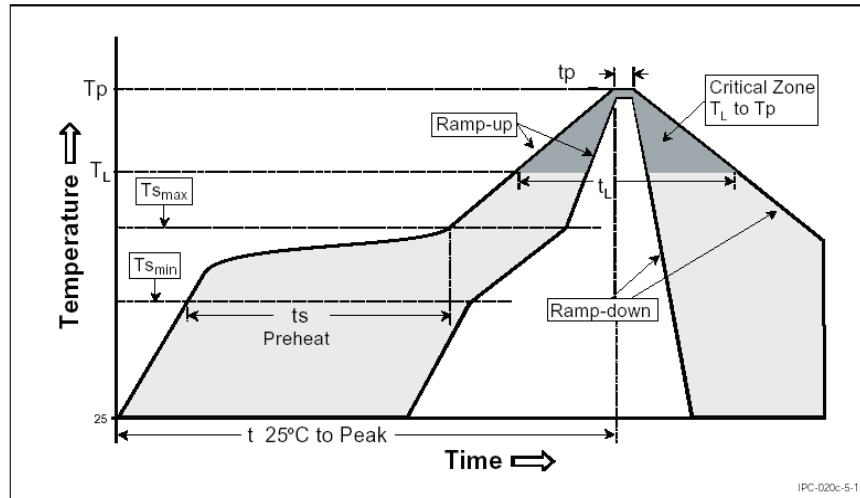

Temperature Profile for Table 6.

Table 6.

Profile Feature	Lead Free Assembly
Average Ramp-Up Rate ($T_{s_{max}}$ to T_p)	3°C / second max
Preheat Temperature Min ($T_{s_{min}}$)	150°C
Preheat Temperature Max ($T_{s_{max}}$)	200°C
Preheat Time ($t_{s_{min}}$ to $t_{s_{max}}$)	60 - 180 seconds
Time Maintained Above Temperature T_L	217°C
Time Maintained Above Time (t_L)	60 - 150 seconds
Peak / Classification Temperature (T_p)	260°C
Time Within 5°C of Actual Peak Temperature (t_p)	20 - 40 seconds
Ramp-Down Rate	6°C / second max
Time 25°C to Peak Temperature	8 minutes max

Note for Table 6:

I. All temperatures refer to the application Printed Circuit Board (PCB), measured on the surface adjacent to the package body.

Mechanical Dimensions

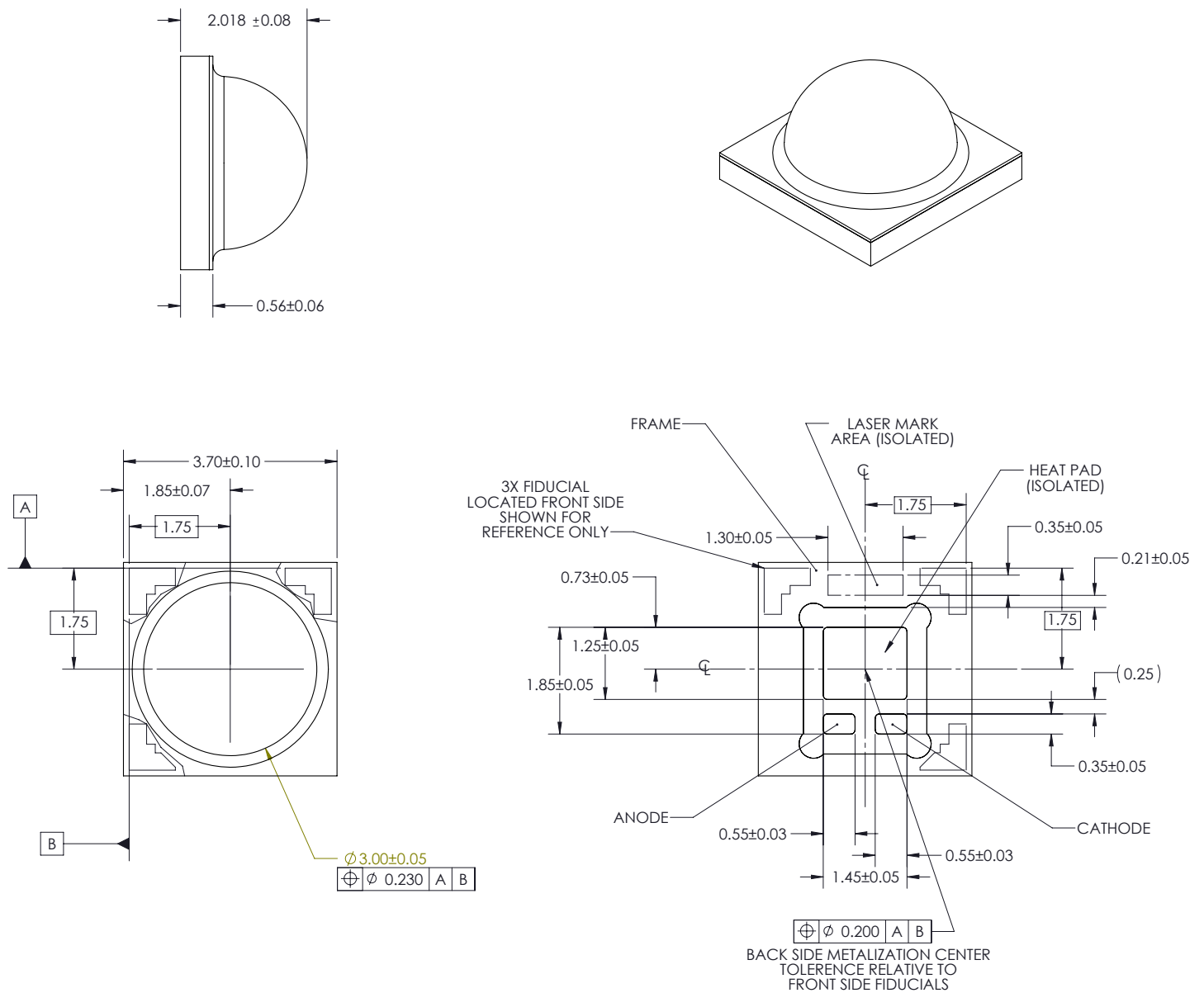

Figure 2.

Notes for Figure 2:

1. Do not handle the device by the lens. Excessive force on the lens may damage the lens itself or the interior of the device.
2. Drawings not to scale.
3. All dimensions are in millimeters.
4. The thermal pad is electrically isolated from the anode and cathode contact pads.

Solder Pad Design

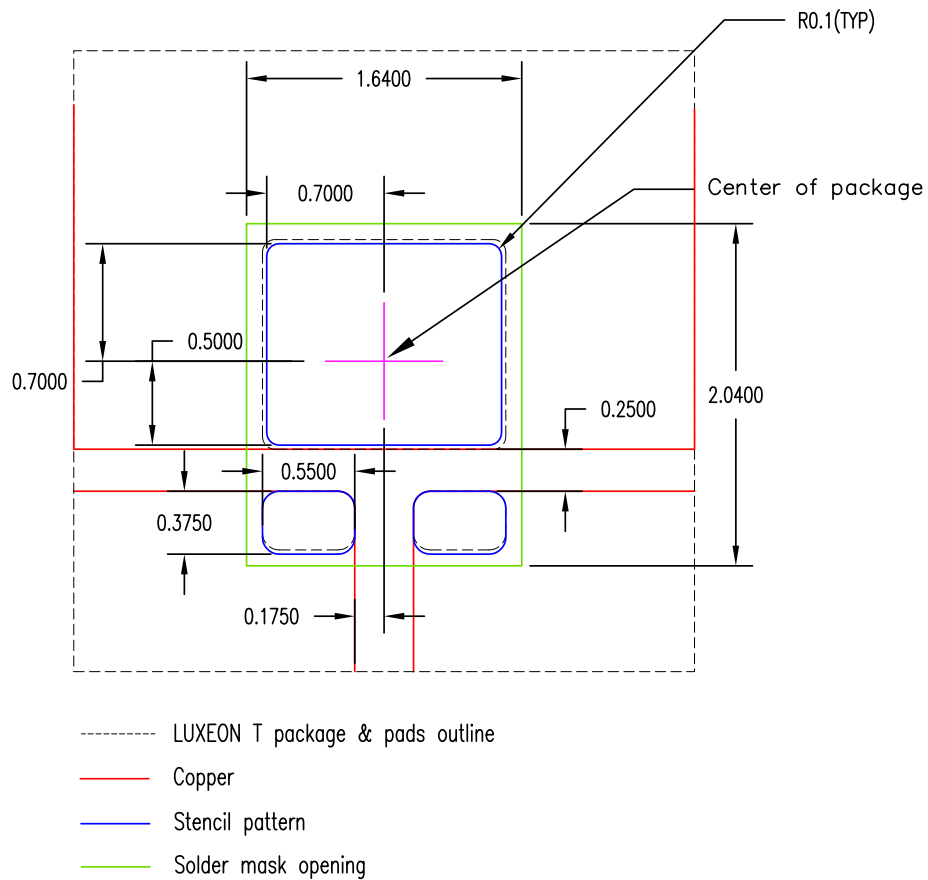

Figure 3. Solder pad layout.

Notes for Figure 3:

1. The photograph shows the recommended LUXEON H50-2 layout on Printed Circuit Board (PCB).
2. For more information on assembly and layout, please refer to Technical Note 106 (TN106).
3. The .dwg files are available at www.philipsumileds.com and www.philipsumileds.cn.com.

Relative Spectral Distribution vs. Wavelength Characteristics

Relative Spectra at Test Current, Thermal Pad Temperature = 85°C

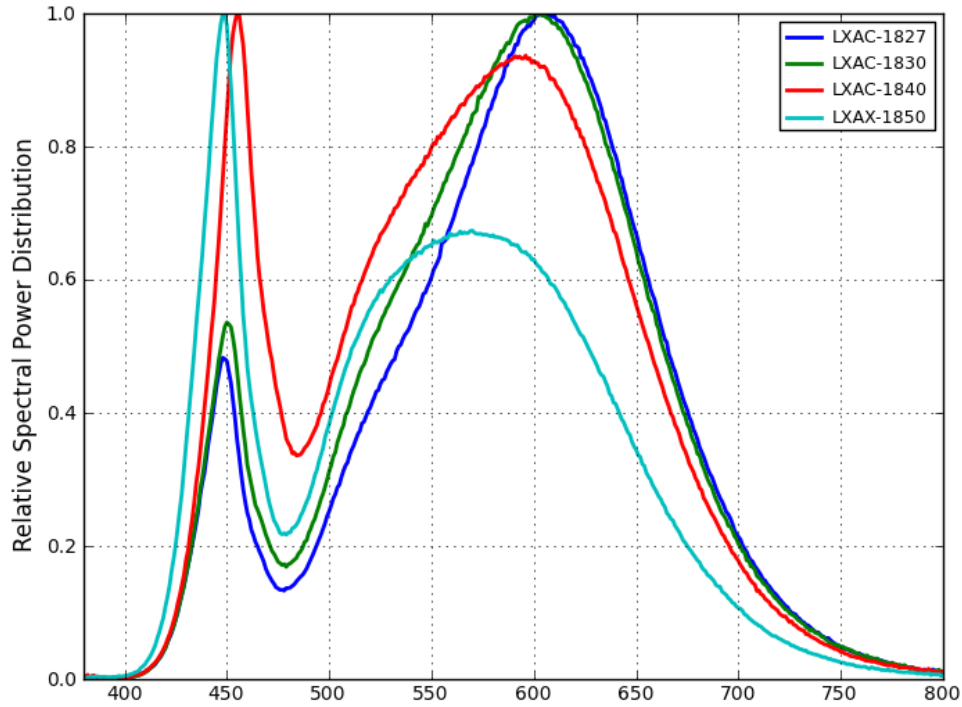

Figure 4. Color Spectrum of LXAC-18xx.

Relative Spectra at Test Current, Thermal Pad Temperature = 85°C

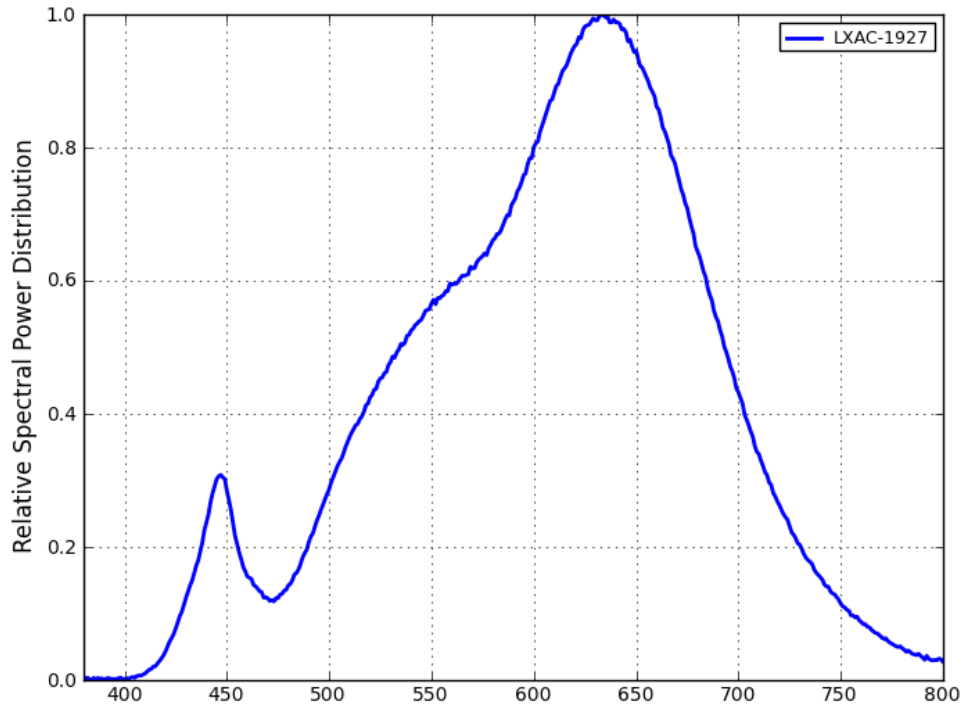

Figure 5. Color Spectrum of LXAC-19xx.

Relative Spectra at Test Current, Thermal Pad Temperature = 85°C

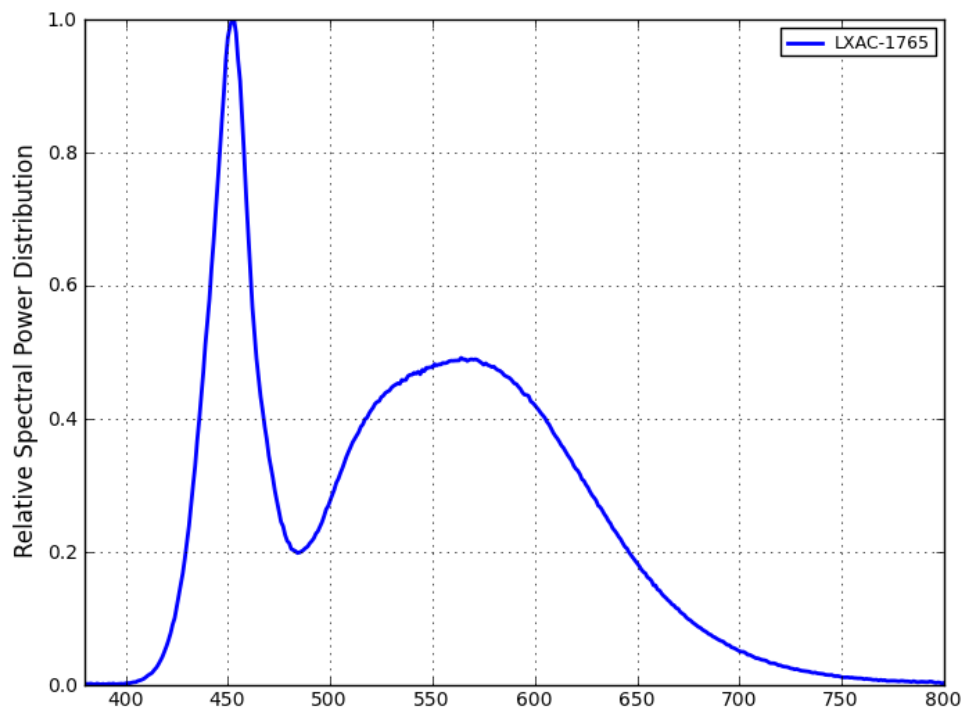

Figure 6. Color Spectrum of LXAC-17xx.

Light Output Characteristics

Relative Light Output vs. Thermal Pad Temperature, Test Current = 40 mA

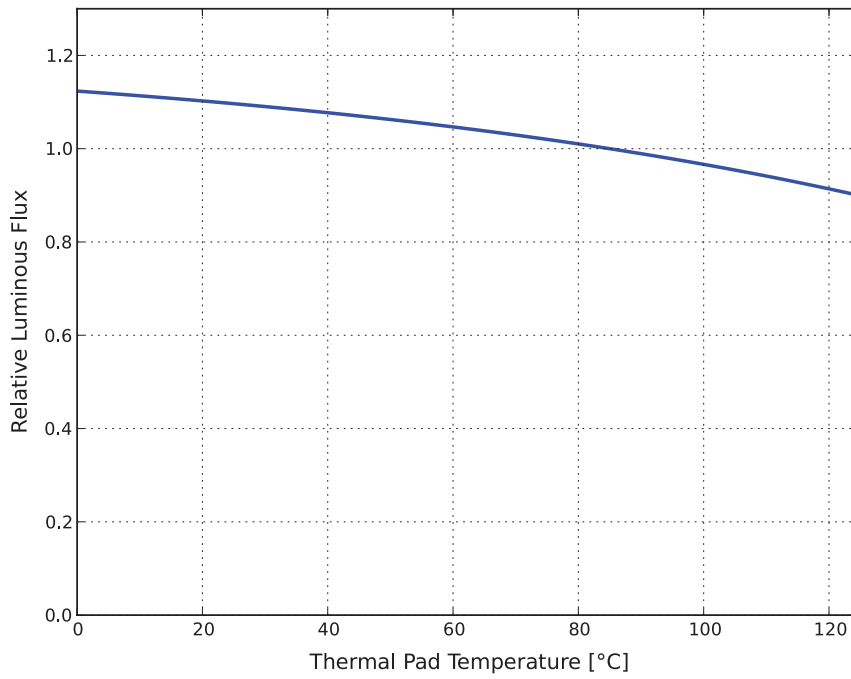

Figure 7. Relative light output vs. thermal pad temperature, LXAC-I827 and LXAC-I830.

Relative Light Output vs. Forward Current, Thermal Pad Temperature = 85°C

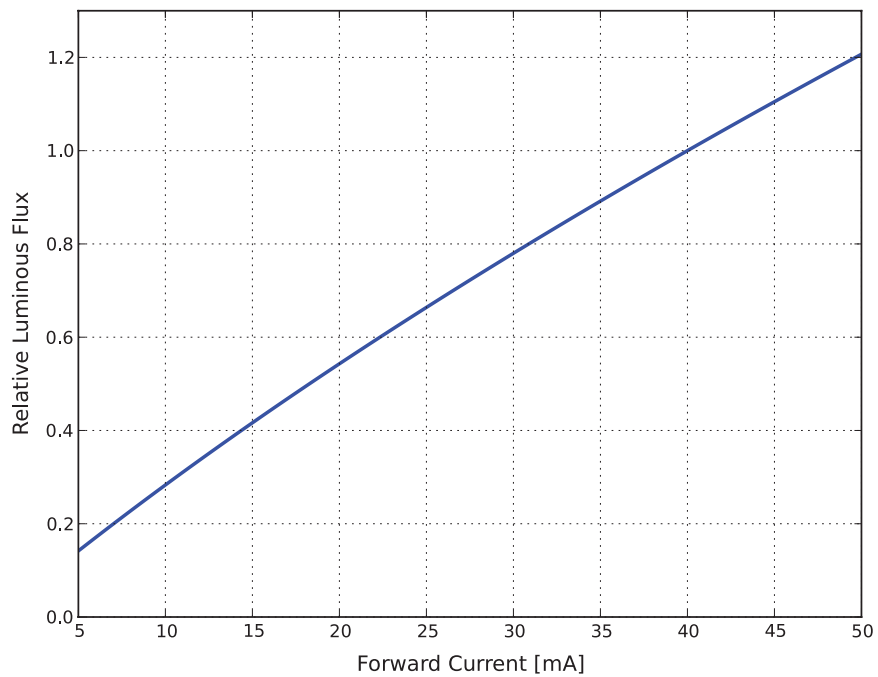

Figure 8. Typical relative luminous flux vs. forward current, LXAC-I827 and LXAC-I830.

Typical Forward Current Characteristics

Thermal Pad Temperature = 85°C

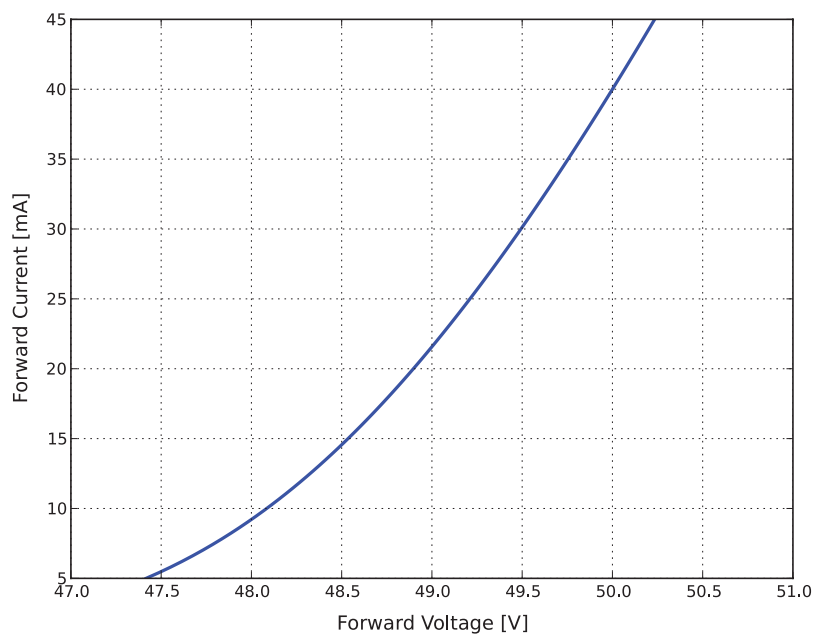

Figure 9. Typical emitter efficacy versus forward current, solder pad temperature = 25°C.

Typical Radiation Patterns

Typical Spatial Radiation Pattern

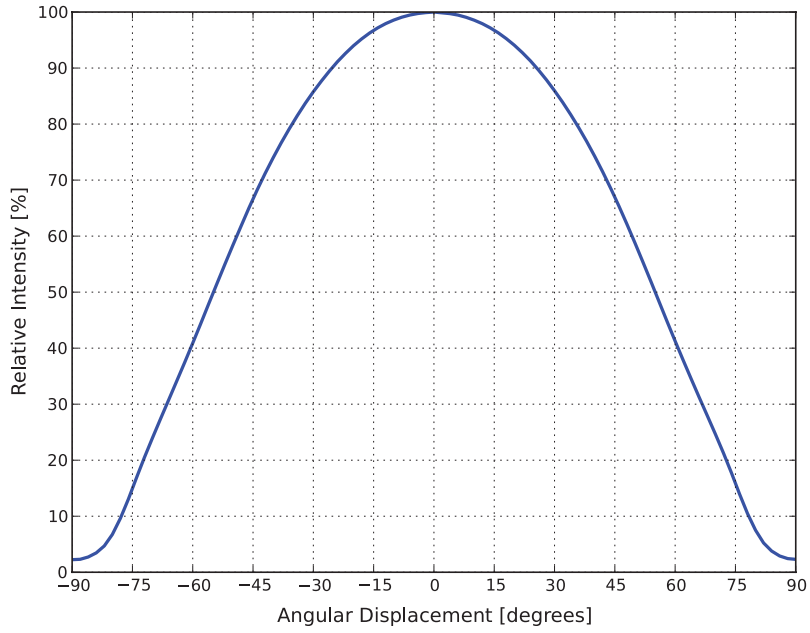

Figure 10. Typical representative spatial radiation pattern for LXAC-Ixxx.

Typical Polar Radiation Pattern

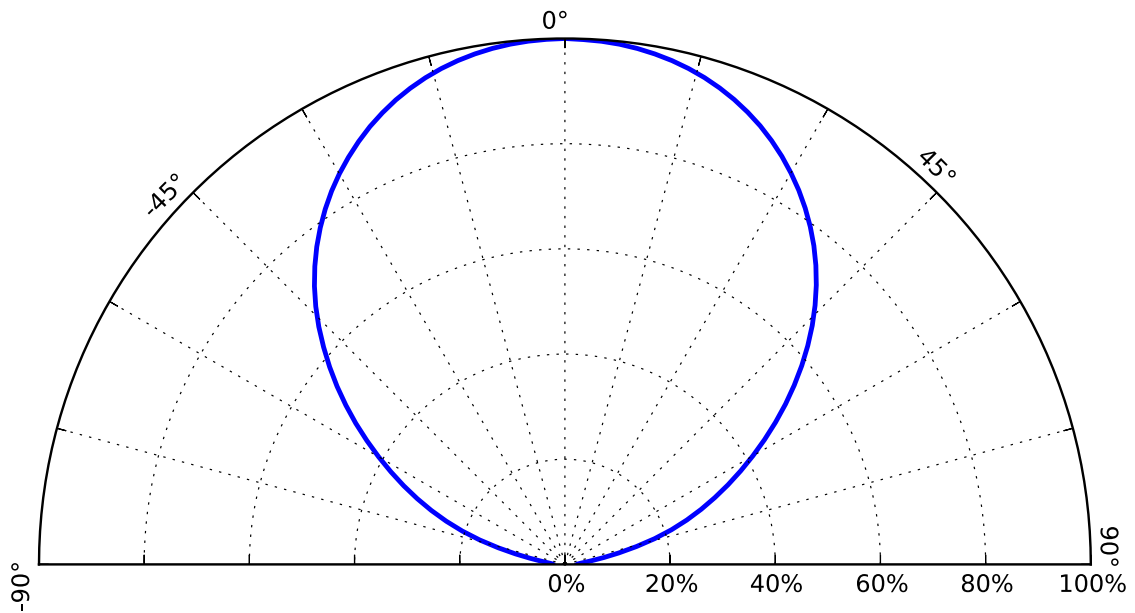

Figure 11. Typical representative polar radiation pattern for LXAC-Ixxx.

Emitter Pocket Tape Packaging

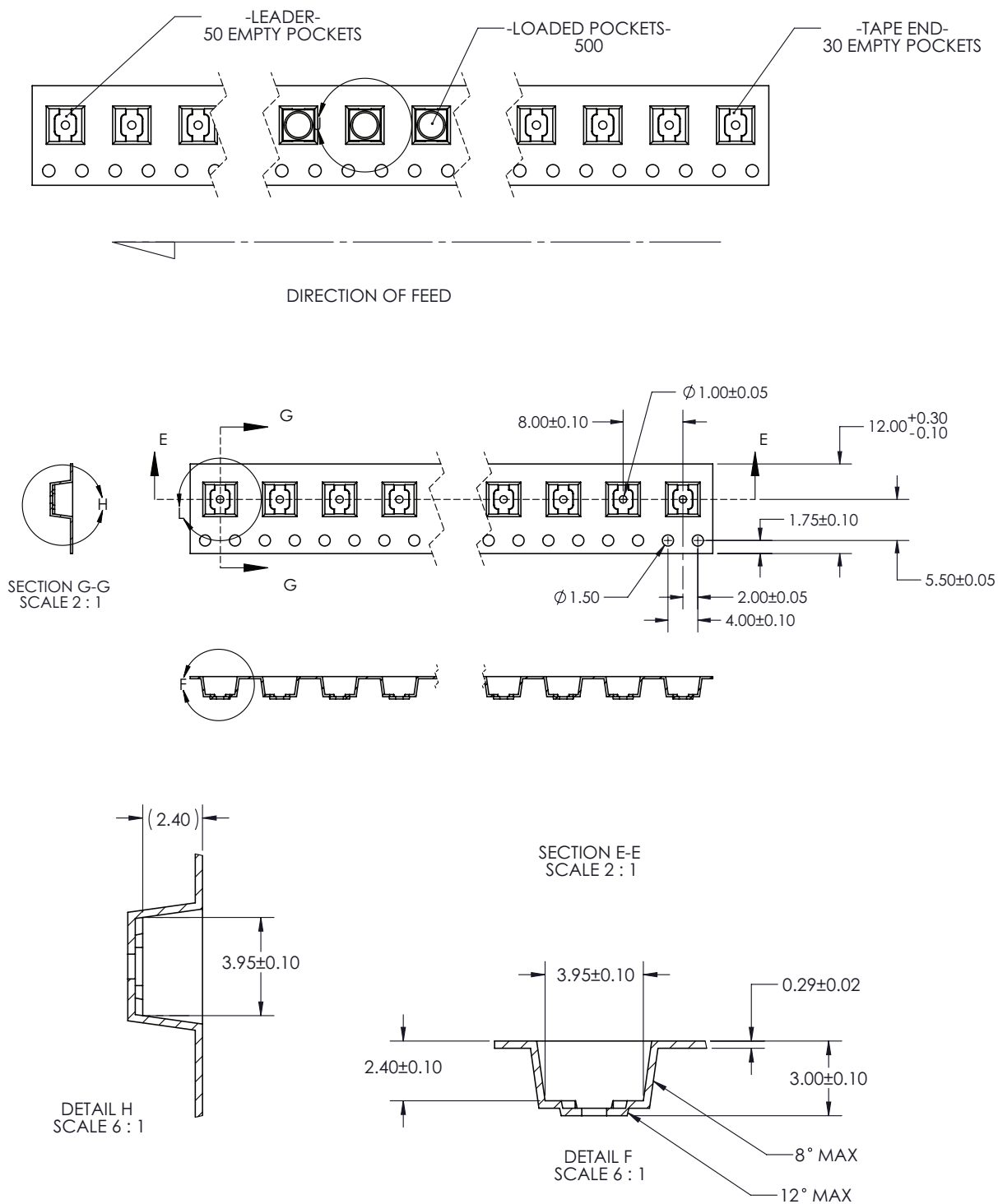

Figure 12. Emitter pocket tape packaging.

Emitter Reel Packaging

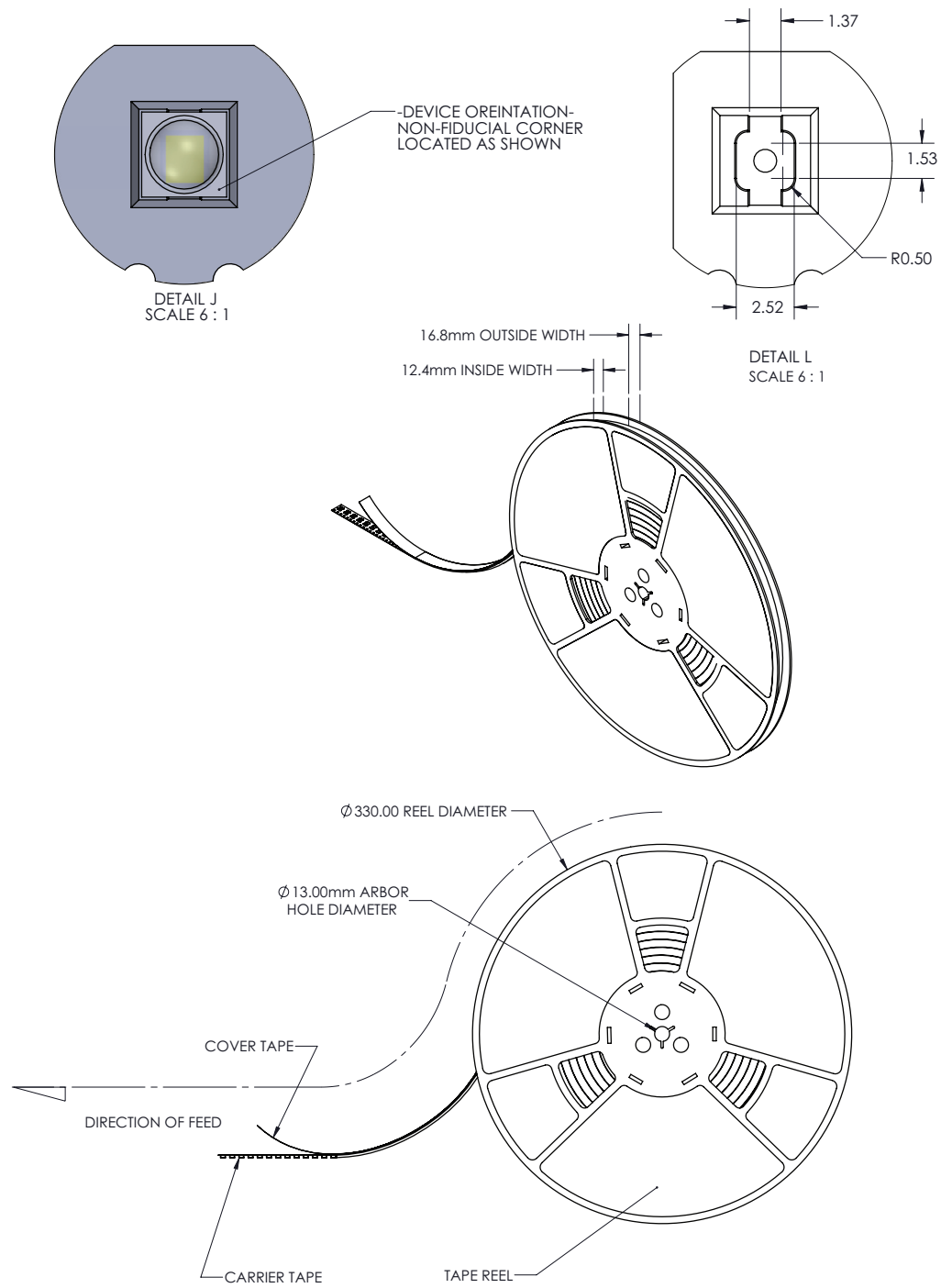

Figure 13. Emitter reel packaging.

Product Binning and Labeling

Purpose of Product Binning

In the manufacturing of semiconductor products, there are variations in performance around the average values given in the technical data sheets. For this reason, Philips Lumileds bins the LED components for luminous flux, color and forward voltage (V_f).

Decoding Product Bin Labeling

In the manufacturing of semiconductor products, there are variations in performance around the average values given in the technical data sheets. For this reason, Philips Lumileds bins the LED components for luminous flux, color and forward voltage (V_f).

Reels of 2700K, 3000K emitters are labeled with a four digit alphanumeric CAT code following the format below.

ABCD

A = Flux bin (C, D, etc.)

B and C = Color bin (73, 7A, 7B etc.)

D = V_f bin (E, F, G, etc.)

Luminous Flux Bins

Table 7 lists the standard photometric luminous flux bins for LUXEON H50-2 emitters (tested and binned at 40 mA and $T_j = 85^\circ\text{C}$). Although several bins are outlined, product availability in a particular bin varies by production run and by product performance. Not all bins are available in all colors.

Table 7. Flux Bins - All Colors

Bin Code	Minimum Photometric Flux (lm)	Maximum Photometric Flux (lm)
B	110	120
C	120	130
D	130	140
E	140	150
F	150	160
G	160	170
H	170	180
J	180	190
K	190	200
L	200	210
M	210	220
N	220	230
P	230	240
Q	240	250

Forward Voltage Bins

Table 8 lists minimum and maximum V_f bin values per emitter. Although several bins are outlined, product availability in a particular bin varies by production run and by product performance.

Table 8. V_f Bins

Bin Code	Minimum Forward Voltage (V)	Maximum Forward Voltage (V)
E	48.5	49
F	49	49.5
G	49.5	50
H	50	50.5
J	50.5	51
K	51	51.5
L	51.5	52

Color Bin Structure

LUXEON H50-2 Color Bin Structure

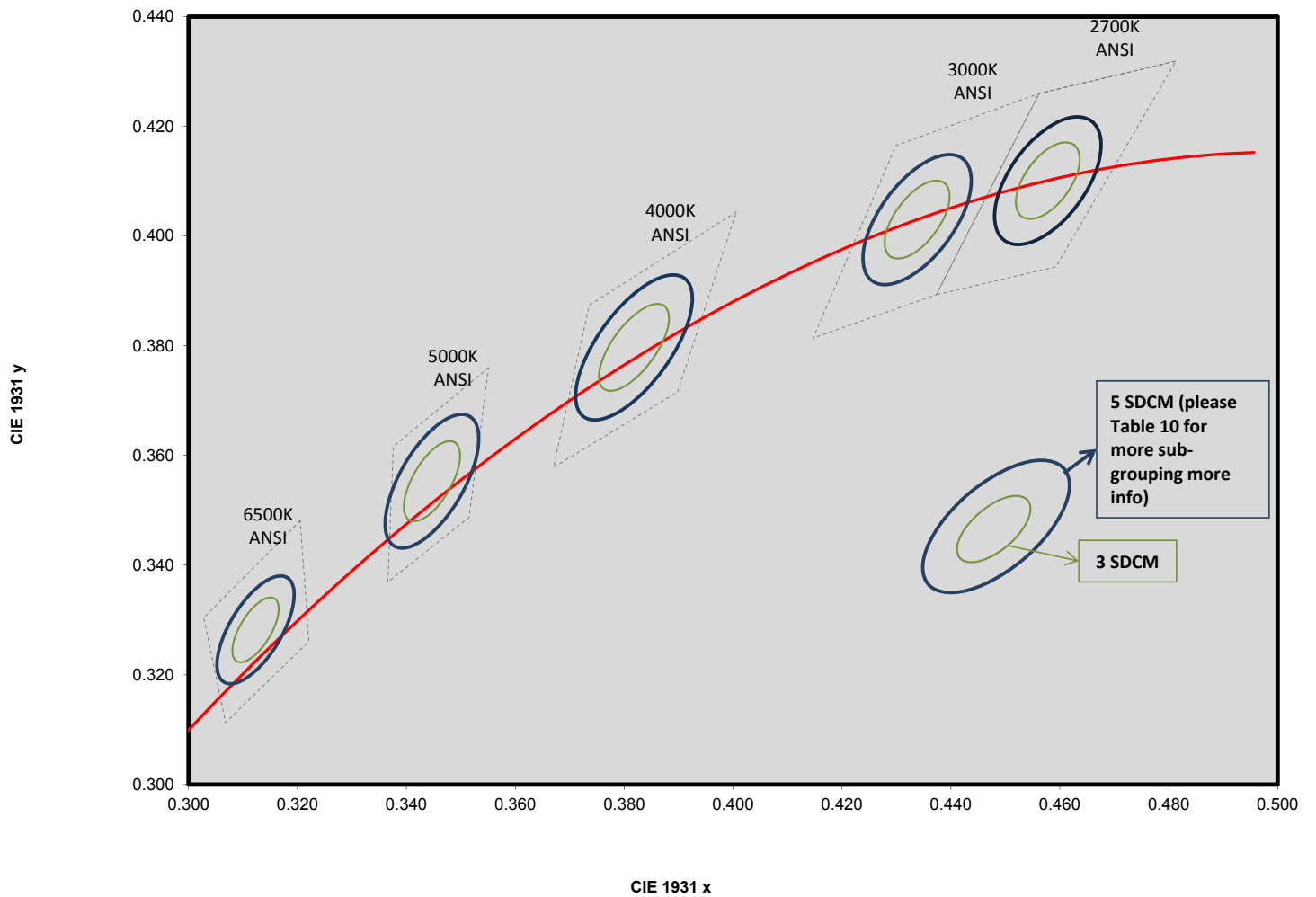

Figure 14. LUXEON H50-2 color bin structure for 2700K and 3000K.

LUXEON H50-2 3-step and 5-step MacAdam Ellipse Color Definition

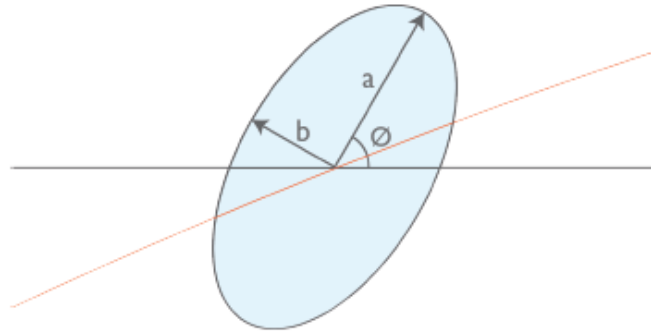

Table 9. 3-step MacAdam Ellipse

Based on: ANSI C78.376-2001 and ANSI C78.377-2008					
ANSI Bins	x_{center}	y_{center}	Major Axis, a	Minor Axis, b	Elliptical angle* (deg)
2700K	0.4578	0.4101	0.00810	0.00420	53.70°
3000K	0.4338	0.4030	0.00834	0.00408	53.22°
4000K	0.3818	0.3797	0.00939	0.00402	53.72°
5000K	0.3447	0.3553	0.00822	0.00354	59.62°
6500K	0.3123	0.3282	0.00669	0.00285	58.57°

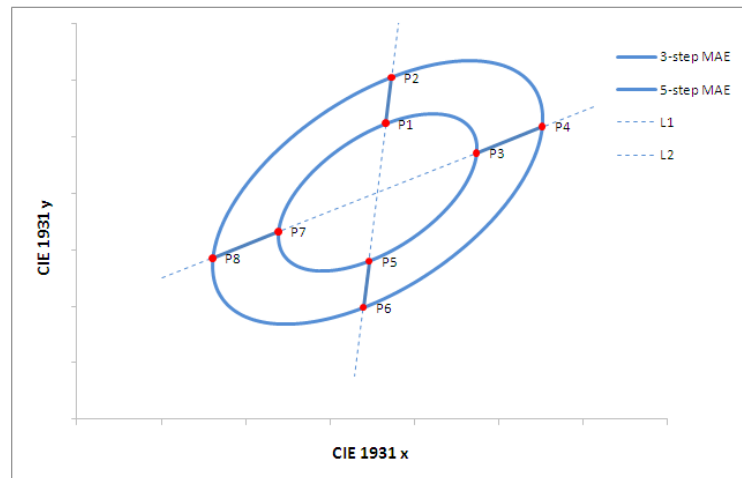

Table 10. 5-step MacAdam Ellipse

Based on: ANSI C78.376-2001 and ANSI C78.377-2008										
ANSI Bins	2700K		3000K		4000K		5000K		6500K	
Intersection Points	x	y	x	y	x	y	x	y	x	y
X_v, Y_0	0.4578	0.4101	0.4338	0.4030	0.3818	0.3797	0.3447	0.3553	0.3123	0.3282
P1	0.4583	0.4162	0.4340	0.4089	0.3815	0.3853	0.3441	0.3604	0.3116	0.3320
P2	0.4586	0.4203	0.4342	0.4128	0.3813	0.3891	0.3437	0.3637	0.3111	0.3345
P3	0.4637	0.4136	0.4397	0.4066	0.3881	0.3835	0.3497	0.3583	0.3164	0.3307
P4	0.4676	0.4159	0.4437	0.4089	0.3922	0.3860	0.3530	0.3603	0.3191	0.3323
P5	0.4573	0.4040	0.4336	0.3971	0.3821	0.3741	0.3453	0.3502	0.3130	0.3244
P6	0.4570	0.3999	0.4334	0.3932	0.3823	0.3703	0.3457	0.3469	0.3135	0.3219
P7	0.4519	0.4066	0.4279	0.3994	0.3755	0.3759	0.3397	0.3523	0.3082	0.3257
P8	0.4480	0.4043	0.4239	0.3971	0.3714	0.3734	0.3364	0.3503	0.3055	0.3241

Note for Tables 9 & 10:

I. Philips Lumileds maintains a tester tolerance of ± 0.005 on x, y color coordinates.

Company Information

Philips Lumileds is a leading provider of LEDs for everyday lighting applications. The company's records for light output, efficacy and thermal management are direct results of the ongoing commitment to advancing solid-state lighting technology and enabling lighting solutions that are more environmentally friendly, help reduce CO2 emissions and reduce the need for power plant expansion. Philips Lumileds LUXEON® LEDs are enabling never before possible applications in outdoor lighting, shop lighting, home lighting, digital imaging, display and automotive lighting.

Philips Lumileds is a fully integrated supplier, producing core LED material in all three base colors, (Red, Green, Blue) and white. Philips Lumileds has R&D centers in San Jose, California and in the Netherlands, and production capabilities in San Jose, Singapore and Penang, Malaysia. Founded in 1999, Philips Lumileds is the high flux LED technology leader and is dedicated to bridging the gap between solid-state technology and the lighting world. More information about the company's LUXEON LED products and solid-state lighting technologies can be found at www.philipslumileds.com.

Philips Lumileds Lighting Company shall not be liable for any kind of loss of data or any other damages, direct, indirect or consequential, resulting from the use of the provided information and data. Although Philips Lumileds Lighting Company has attempted to provide the most accurate information and data, the materials and services information and data are provided "as is" and Philips Lumileds Lighting Company neither warranties, nor guarantees the contents and correctness of the provided information and data. Philips Lumileds Lighting Company reserves the right to make changes without notice. You as user agree to this disclaimer and user agreement with the download or use of the provided materials, information and data.



©2013 Philips Lumileds Lighting Company. All rights reserved.
LUXEON is a registered trademark of the Philips Lumileds Lighting Company in the United States and other countries.

www.philipslumileds.com
www.philipslumileds.cn.com